



ELECTRIAL CHAINSAW
RAC2035ECS-A, RAC2040ECS-A



INSTRUCTIONS MANUAL

Read the instructions before using the tool

BUILDER SAS
32, rue Aristide Bergès - ZI 31270 Cugnaux – France
MADE IN PRC 2019



CONTENTS

1. SAFETY WARNINGS	3
2. YOUR PRODUCT	8
3. ASSEMBLY	10
4. OPERATION	11
5. MAINTENANCE AND STORAGE	14
6. DISPOSAL	15
7. DECLARATION OF CONFORMITY	16

1. SAFETY WARNINGS



WARNING Read all safety warnings and all instructions. *Failure to follow the warnings and instructions may result in electric shock, fire and/or serious injury.*

Save all warnings and instructions for future reference. *The term "power tool" in the warnings refers to your mains-operated (corded) power tool or battery-operated (cordless) power tool.*

1) Work area safety

a) **Keep work area clean and well lit.** *Cluttered or dark areas invite accidents.*

b) **Do not operate power tools in explosive atmospheres, such as in the presence of flammable liquids, gases or dust.** *Power tools create sparks which may ignite the dust or fumes.*

c) **Keep children and bystanders away while operating a power tool.** *Distractions can cause you to lose control.*

2) Electrical safety

a) **Power tool plugs must match the outlet. Never modify the plug in any way. Do not use any adapter plugs with earthed (grounded) power tools.** *Unmodified plugs and matching outlets will reduce risk of electric shock.*

b) **Avoid body contact with earthed or grounded surfaces, such as pipes, radiators, ranges and refrigerators.** *There is an increased risk of electric shock if your body is earthed or grounded.*

c) **Do not expose power tools to rain or wet conditions.** *Water entering a power tool will increase the risk of electric shock.*

d) **Do not abuse the cord. Never use the cord for carrying, pulling or unplugging the power tool. Keep cord away from heat, oil, sharp edges or moving parts.** *Damaged or entangled cords increase the risk of electric shock.*

e) **When operating a power tool outdoors, use an extension cord suitable for outdoor use.** *Use of a cord suitable for outdoor use reduces the risk of electric shock.*

f) **If operating a power tool in a damp location is unavoidable, use a residual current device (RCD) protected supply.** *Use of an RCD reduces the risk of electric shock.*

3) Personal safety

a) **Stay alert, watch what you are doing and use common sense when operating a power tool. Do not use a power tool while you are tired or under the influence of drugs, alcohol or medication.** *A moment of inattention while operating power tools may result in serious personal injury.*

b) **Use personal protective equipment. Always wear eye protection.** *Protective equipment such as dust mask, non-skid safety shoes, hard hat, or hearing protection used for appropriate conditions will reduce personal injuries.*

c) **Prevent unintentional starting. Ensure the switch is in the off-position connecting to power source and/or battery pack, picking up or carrying the tool.** *Carrying power tools with your finger on the switch or energizing power tools that have the switch on invites accidents.*

d) **Remove any adjusting key or wrench before turning the power tool on.** *A wrench or a key left attached to a rotating part of the power tool may result in personal injury.*

e) **Do not overreach. Keep proper footing and balance at all times.** *This enables better control of the power tool in unexpected situations.*

f) **Dress properly. Do not wear loose clothing or jewelry. Keep your hair, clothing and gloves away from moving parts.** *Loose clothes, jewelry or long hair can be caught in moving parts.*

g) **If devices are provided for the connection of dust extraction and collection facilities, ensure these are connected and properly used.** *Use of dust collection can reduce dust-related hazards.*

4) Power tool use and care

a) **Do not force the power tool. Use the correct power tool for your application.** *The correct power tool will do the job better and safer at the rate for which it was designed.*

b) **Do not use the power tool if the switch does not turn it on and off.** *Any power tool that cannot be controlled with the switch is dangerous and must be repaired.*

c) **Disconnect the plug from the power source and/or the battery pack from the power tool before making any adjustments, changing accessories, or storing power tools.** *Such preventive safety measures reduce the risk of starting the power tool accidentally.*

d) **Store idle power tools out of the reach of children and do not allow persons unfamiliar with the power tool or these instructions to operate the power tool.** *Power tools are dangerous in the hands of untrained users.*

e) **Maintain power tools. Check for misalignment or binding of moving parts, breakage of parts and any other condition that may affect the power tool's operation. If damaged, have the power tool repaired before use.** *Many accidents are caused by poorly maintained power tools.*

f) **Keep cutting tools sharp and clean.** *Properly maintained cutting tools with sharp cutting edges are less likely to bind and are easier to control.*

g) **Use the power tool, accessories and tool bits etc. in accordance with these instructions, taking into account the working conditions and the work to be performed.** *Use of the power tool for operations different from those intended could result in a hazardous situation.*

5) Service

a) **Have your power tool serviced by a qualified repair person using only identical replacement parts.** *This will ensure that the safety of the power tool is maintained.*

Chain saw safety warnings:

Keep all parts of the body away from the saw chain when the chain saw is operating. Before you start the chain saw, make sure the saw chain is not contacting anything. A moment of inattention while operating chain saws may cause entanglement of your clothing or body with the saw chain.

Always hold the chain saw with your right hand on the rear handle and your left hand on the front handle. Holding the chain saw with a reversed hand configuration increases the risk of personal injury and should never be done.

NOTE For chain saws designed with the guide bar on the left side, the reference to "right hand" and "left hand" positioning is reversed.

Hold the power tool by insulated gripping surfaces only, because the saw chain may contact hidden wiring or its own cord. Saw chains contacting a "live" wire may make exposed metal parts of the power tool "live" and could give the operator an electric shock.

Wear safety glasses and hearing protection. Further protective equipment for head, hands, legs and feet is recommended. Adequate protective clothing will reduce personal injury by flying debris or accidental contact with the saw chain.

Do not operate a chain saw in a tree. Operation of a chain saw while up in a tree may result in personal injury.

Always keep proper footing and operate the chain saw only when standing on fixed, secure and level surface. Slippery or unstable surfaces such as ladders may cause a loss of balance or control of the chain saw

When cutting a limb that is under tension be alert for spring back. When the tension in the wood fibers is released the spring loaded limb may strike the operator and/or throw the chain saw out of control.

Use extreme caution when cutting brushes and saplings. The slender material may catch the saw chain and be whipped toward you or pull you off balance.

Carry the chain saw by the front handle with the chain saw switched off and away from your body. When transporting or storing the chain saw, always fit the guide bar cover. Proper handling of the chain saw will reduce the likelihood of accidental contact with the moving saw chain.

Follow instructions for lubricating, chain tensioning and changing accessories. Improperly tensioned or lubricated chain may either break or increase the chance for kickback.

Keep handles dry, clean, and free from oil and grease. Greasy, oily handles are slippery causing loss of control.

Cut woods only. Do not use chain saw for purposes not intended. For example: do not use chain saw for cutting plastic, masonry or non-wood building materials. Use of the chain saw for operations different than intended could result in a hazardous situation.

Causes and operator prevention of kickback:

Kickback may occur when the nose or tip of the guide bar touches an object, or when the wood closes in and pinches the saw chain in the cut.

Tip contact in some cases may cause a sudden reverse reaction, kicking the guide bar up and back towards the operator.

Pinching the saw chain along the top of the guide bar may push the guide bar rapidly back towards the operator.

Either of these reactions may cause you to lose control of the saw which could result in serious personal injury. Do not rely exclusively upon the safety devices built into your saw. As a chain saw user, you should take several steps to keep your cutting jobs free from accident or injury.

Kickback is the result of tool misuse and/or incorrect operating procedures or conditions and can be avoided by taking proper precautions as given below:

Maintain a firm grip, with thumbs and fingers encircling the chain saw handles, with both hands on the saw and position your body and arm to allow you to resist kickback forces. Kickback forces can be controlled by the operator, if proper precautions are taken. Do not let go of the chain saw.

Do not overreach and do not cut above shoulder height. This helps prevent unintended tip contact and enables better control of the chain saw in unexpected situations.

Only use replacement bars and chains specified by the manufacturer. Incorrect replacement bars and chains may cause chain breakage and/or kickback.

Follow the manufacturer's sharpening and maintenance instructions for the saw chain. Decreasing the depth gauge height can lead to increased kickback.

Additional instructions

- It is recommended to use of a residual current device with a tripping current of 30 mA or less.
- **WARNING!** When using this type of power tool, basic precautions should always be followed to reduce the risk of fire, electric shock and injury.
- Read all instructions carefully before attempting to use this product and retain these instructions. Be familiar with all the operations described in these operating instructions. This product must be operated by experienced users.
- If you are giving this machine to others, please also provide them with this instructions manual.
- Also read all markings on the product. The symbols on the tools are explained in the manual.
- Use this machine as described in this instruction manual. It is strictly forbidden to use this tool for applications other than those described in this manual.
- Failure to follow these instructions can result in serious injuries and, in some cases, death.

- This product is intended for private domestic use only. Do not use it for commercial purposes.
- Never let people unfamiliar with these instructions or children use this product.
- National regulations may limit the use of the machine.
- People under the age of 18 must not use this product
- Keep in mind that the operator or user is responsible for accidents or risks to other persons or their property.
- Do not use the tool if you are drunk, tired, under the influence of drugs or ill. Do not use the tool if you are not in an adequate physical condition.
- This tool is intended for outdoor use. Never use it indoors.
- When transporting the machine:
 - Secure the machine during transport to prevent, damage or injury.
 - Use a carrying case to protect the cutter during transport.
- Keep people and animals away from the work area. Children and people who do not know how to use this tool should not touch it and handle it.
- Keep them at least 15 m from the machine during operation,
- Use the product only under daylight or under good artificial light.
- When using the machine, always wear full protective equipment including a helmet, protective mask, ear protection, gloves, non-slip footwear and protective clothing.
- Wear appropriate clothing. Do not wear loose or unbuttoned shirts. Do not wear jewellery that may come in contact with moving parts. If you have long hair, tie it down and wear an appropriate safety helmet.
- Do not operate the product with damaged guards or shields in place.
- Keep hands and feet of the appliance at all times and especially when turning the appliance off and on.
- Do not use the tool in an area where ventilation is poor. Gas emissions can cause injury.
- Do not work when it rains and in bad weather. Do not use the tool in damp locations.
- Do not use the tool in the presence of flammable liquids or gases.
- Caution: The machine releases gases when it is used. Avoid coming into contact with these gases.
- Keep the work area clear. Before working, inspect the work area and remove any materials or objects that could cause accidents.
- Do not force the tool.
- Use only the accessories supplied or recommended by the manufacturer. Use of other accessories may result in an accident. Read the "Technical Data" section of this instruction manual or ask your dealer for advice.
- Do not lean. Keep a good seating/footing and balance at all times.
- To maintain tools and accessories carefully, keep cutting tools sharp and clean for better and safer performance. Follow the instructions in this manual to lubricate and change accessories.
- Always inspect the machine before and after operation. If the tool is damaged or faulty, stop using the tool and bring it to an authorized service for inspection and repair.
- Turn off the tool after use, when you leave it unattended, when changing these accessories and before servicing.
- Keep handles dry, clean and free from oil and grease.
- Be concentrated when using the tool. Look at what you do, use good sense and do not use the tool when you are tired.
- Remove the blade guard before using the tool.
- A damaged guard or other part must be properly repaired or replaced by an authorized service center, unless otherwise specified in this instruction manual.
- Do not use the tool if the starter is not working (if it cannot be turned ON and OFF).
- Place the equipment in a well-lit area on a flat, stable, dry and well-ventilated surface, away from flammable materials and with plenty of space for sparking and sharpen waste.
- Do not allow anyone, especially children, to come within a radius of at least five meters around the work area when all work is in progress.
- Immediately stop the tool in the event of a malfunction of the motor or the ON/OFF button or in case of unusual noise.
- Do not use the tool if the starter is damaged.
- Do not move the chain with your hand with the wheel moving.
- Do not stop the chain with your hands or other objects.
- Treat the chain teeth with caution during operation; they can cause severe cuts.
- When not in use, the machine must be stored in a dry, locked place out of the reach of children.
- Before using the product and after any shock, please check it for signs of wear or damage. Please carry out repairs if necessary.
- Always switch off the machine:
 - Every time you leave the device unattended;
 - Before releasing an obstruction;
 - Before checking, cleaning or working on the product;
 - After hitting a foreign object;
 - Every time the product starts to vibrate abnormally.

- Pay attention to foot and cutting injuries.
- Inspect and regularly service the product. Repairs should be carried out only by an authorized service center or a similar qualified specialist.
- When not in use, store the product out of the reach of children.
- Children should not play with plastic bags, sheets and small parts! Keep them out of the reach of children. There is a danger of suffocation!
- When transporting the tool, always add the blade guard to the blade. Always carry the tool by holding the handle, never the blade.
- Do not use the product on a slippery surface.
- Do not use the product on steep, slippery slopes.
- When planning your work schedule, allow enough time for rest. Limit continuous use of the device, e.g. use 30 ~ 40 minutes per session, and take 10 ~ 20 minutes of rest between work sessions. Work a maximum of two hours per day
- If the machine has struck foreign objects, check if the tool is damaged and bring it to repair if necessary.
- Do not place any part of the body on the chain when the chainsaw is operating. Before starting the chain saw, make sure that the chain is not in contact with anything. A moment of inattention during use may cause your clothing or body part to stick to the chain.
- Always hold the chainsaw back handle with your right hand and the front handle with your left hand. Hold the chainsaw by inverting your hands increases the risk of personal injury and should never be used.
- For the chainsaw designed with the chain guide on the left side, the reference to the "right hand" and "left hand" positions is reversed.
- When cutting a branch that is under stress, pay attention to the risk of elastic return. When the tension of the wood fibres is released, the spring-loaded limb may strike the operator and / or project the chain saw out of control.
- Exercise extreme caution when cutting brush and young shrubs. Fine materials can grip the cutting chain and be thrown as a whip in your direction, or you lose balance under the effect of traction.
- Follow the instructions for lubrication, tension and chain change accessories. A chain whose tension and lubrication are incorrect can either break or increase the risk of rebound.
- Keep handles dry, clean and free of oil and grease. Oily, greasy grips are slippery and cause loss of control.
- Cut only wood, as well as for pruning and cutting wood. Do not use the chain saw for any other purpose. For example: do not use it to cut plastic, masonry or construction materials other than wood. Using the chain saw for operations other than those specified may result in hazardous situations.
- Be careful when using the machine during stormy weather. Do not use the machine during lightning, thunderstorms or in bad weather in general.
- There is advantage of using a spiked bumper when cutting thick branches.
- The tool must be used with an extension cable; please contact our service or ask your retailer for advice about the type and length of extension cable that can be used with this chainsaw.

During maintenance and storage

- Stop the tool and wait until it stops. Make sure all moving parts have come to a standstill.
- Allow the machine to cool before performing inspection, adjustments, maintenance, servicing and storage.
- Store the tool where fuel vapour will not reach a flame or spark.
- When transporting and storing, always place the tool in its transport guard and protective device on it.

Residual risks

Even if you use this product in compliance with all safety requirements, the potential risks of injury and damage remain. The following hazards may arise from the structure and design of this product:

- There are harmful health consequences resulting from the emission of vibrations if the product is used for long periods of time or not properly managed and properly maintained.
- There is risk of injury and property damage due to attachments or the sudden impact of hidden objects when using the blade.
- Risk of injury to persons and property caused by flying objects.
- Prolonged use of this product exposes the operator to vibration and can produce so-called "white finger" disease. To reduce the risk, wear gloves and keep your hands warm.
- If any of the symptoms of "white finger syndrome" occur, seek immediate medical attention. Symptoms of the "white finger" include numbness, loss of sensitivity, tingling, pain, loss of strength, colour changes or skin condition. These symptoms usually appear on the fingers, hands or wrists. Risk increases at low temperatures.

Symbols



Warning symbol



Read and refer to these operating instructions



protection

Wear hearing protection and eyes



Value of sound emission according to European Directive 2000/14/EC



This tool must be used by persons trained to cut down trees; Read this instruction manual!



The contact of the end of the bar with any object must be avoided.



Do not operate the tool with one hand. Always hold it with both hands.



Do not use the tool when raining



Pull the plug out from the socket immediately when the cable is damaged or entangled or split



Class II product



Wear protective gloves.



Wear protective foot wear.



Attention, electrical shock!



Keep viewers away from work area.

Intended use

The tool should only be used to cut trees. Do not use it for other applications.

This product should not be used outside of domestic premises e.g. for cutting firewood in forested areas.

The use of this product in case of rain or humid environment is prohibited.

This product is intended for private domestic use only.

Use this multifunction tool only as described in this manual and only for the intended use as described above.

Any other use might lead to damage of the appliance, property or personal injury.

No liability will be accepted for damage resulting from improper use or non-compliance with this manual.

2. YOUR PRODUCT

a. **Description**

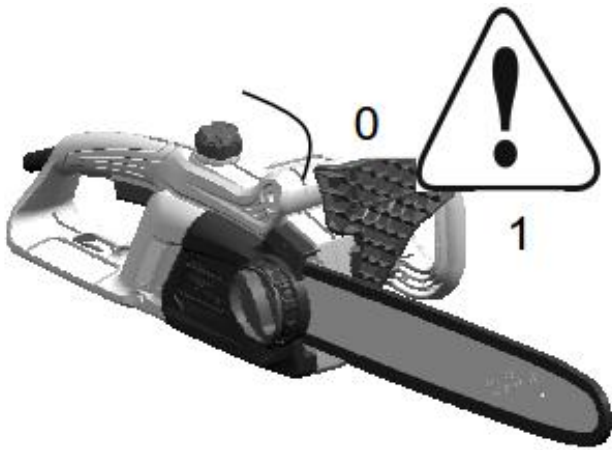

Fig. 1

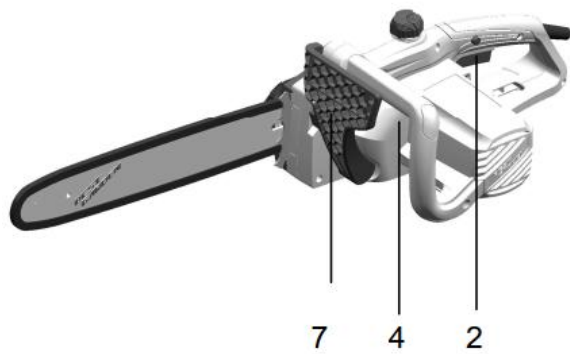
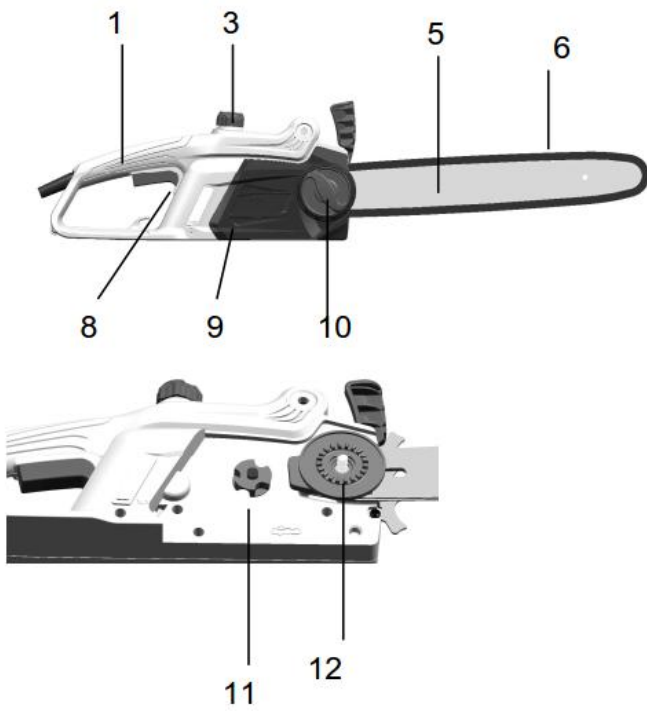

Fig. 2

1. Rear handle
2. Safety lock-off button
3. Chain oil cap
4. Front handle
5. Guide bar with sprocket
6. Chain
7. Safety chain brake lever
8. Main switch
9. Chain cover
10. SDS system
11. Sprocket
12. Adjustable knob

b) Technical data:

Model	RAC2040ECS-A	RAC2035ECS-A
Tension	230V-240V~ 50Hz	230V-240V~ 50Hz
Power	2000W	2000W
Max speed of the spindle	5500/min	5500/min
Cutting length	400mm	350mm
Chain speed	10.2m/s	10.2m/s
Guide Bar	2181-713303(16",0,050")	140SDEA041(14",0,0.50")
Chain	2484-713302 (16" 3/8" 57Teach)	91PJ052X (14" 3/8", 52teech)
Weight with bar and chain	3.3 kg	3.3 kg
Sound Pressure Uncertain K	L _{pA} : 92.1 dB(A) Uncertain K _{pA} =3dB(A)	L _{pA} : 92.1 dB(A) Uncertain K _{pA} =3dB(A)
Sound power	L _{wA} : 104.2dB(A) K _{wA} =3dB(A)	L _{wA} : 104.2dB(A) K _{wA} =3dB(A)
Guaranteed power level	L _{wA} : 107dB(A) (2000/14/EC)	L _{wA} : 107dB(A) (2000/14/EC)
Vibration Uncertain K	Main handle: 13.12m/s ² Rear handle: 9.34m/s ² 1.5m/s ²	Main handle: 13.12m/s ² Rear handle: 9.34m/s ² 1.5m/s ²

Information:

- The declared vibration total value has been measured in accordance with a standard test method and may be used for comparing one tool with another;
- The declared vibration total value may also be used in a preliminary assessment of exposure.

Warning:

- that the vibration emission during actual use of the power tool can differ from the declared total value depending on the ways in which the tool is used; and
- of the need to identify safety measures to protect the operator that are based on an estimation of exposure in the actual conditions of use (taking account of all parts of the operating cycle such as the times when the tool is switched off and when it is running idle in addition to the trigger time).

Wear hearing protection.

3. ASSEMBLY

a. **Assembly of the chain guide**

IMPORTANT: The machine must not be started during assembly. Wear protective gloves when handling the blade.

Your chain saw is supplied one SDS system for assemble and adjust quickly for chain tension. The outside ring (part 1) adjusts the tension of the chain and the inner screw adjusts the tension of the bar. Turn the inner screw (part 2) of the SDS counter-clockwise to open the chain over. (See Fig.3)

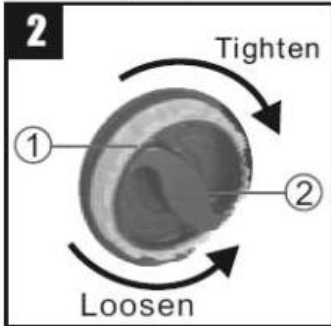

Fig. 3

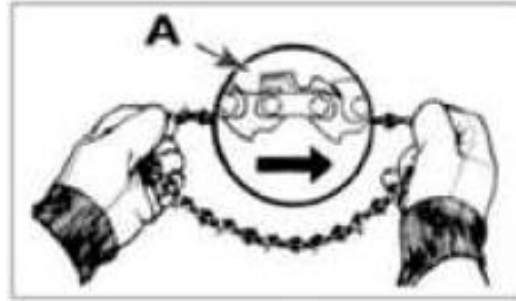

Fig. 4a

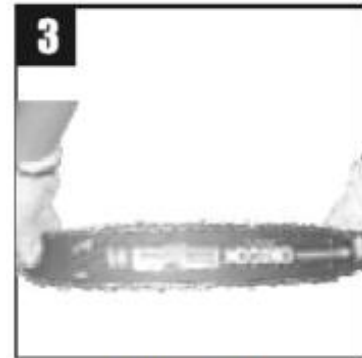

Fig. 4b

1). Unpack all parts carefully.

2). Place the chain saw on any suitable flat surface.

3). Spread the saw chain out with the cutting edges (A) of the chain pointing in the direction of rotating. Slide the saw chain into the slot around the chain bar. Ensure chain is in correct running direction.

(See Fig.4a, 4b)

4). Fit the chain bar onto the drive sprocket (11) and fastening bolt, and assemble safety guard. (See Fig. 5)

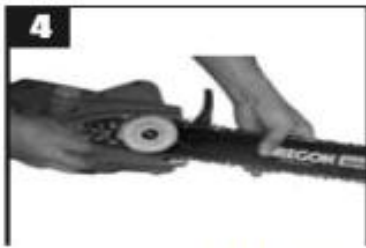

Fig. 5

5) The chain is not yet tensioned now. Tensioning the chain applies as described under "Tensioning chain". After running the chain saw around 1 hour, adjust the chain tension to 2mm by applying 9N of torque

4. OPERATION

Before using the chainsaw, inspect the work area. This must be cleared. Remove any branches, obstacles and other items that may cause damage during cutting.

The unit should always be filled with oil for blade lubrication. Check the level before the use and refill when necessary.

1. **Filling with lubrication oil**

The tool always must be filled with lubrication oil (for the blade). Check the level oil the tank. When the oil arrives at the minimum level, the tank shall be completely filled.



To add lubrication oil, open the tank by removing the cap. Put directly the oil in the tank. Close the tank with its cap.



Open and close

2. **Starting and stopping**

Note: Ensure the brake is working efficiently. Check its operation every time before commencing work with it.

- Connect the tool to a mains power supply.
- Depress the safety lock off button (2) whilst squeezing the main switch (8).
- Release the main switch to stop the tool

3. **Main settings**

a. **Release of the chain brake**

In the event of a kickback occurring, the left hand should come into contact with the chain brake stopping the chain immediately by moving it to position '0'. See fig 1.

The operation of the chain brake must be checked prior to each use.

To reset the chain brake disconnects from the mains and snaps it backwards (towards the operator) into position '1'. See fig 1. Re-check the chain tension before re-starting

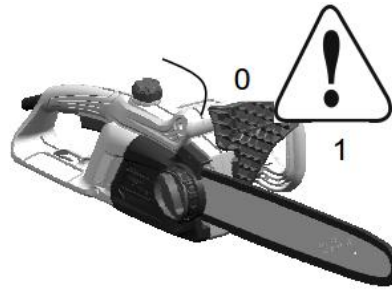

Fig. 1

b. Sharpening of the chain

For best performance, we strongly recommend that you periodically sharpen the chain. The chain can either be sharpened by a professional or by yourself by providing you with a sharpening guide (make sure you know how to use it).

The chain must be sharpened when:

- Wood chips have become powder
- To make a normal cut, force on the tool
- The cut is not straight
- Vibration increases

c. Checking the lubrication of the chain

Warning: Check the automatic oil function before each use.

Check the automatic operation of the chain lubrication by pointing the tip of the switched –on saw towards a piece of paper laying on the ground, if a patch of oil appears and becomes larger, then the automatic oil function is working.

d. Release of a jammed saw

If the saw gets stuck during cutting, the operators should:

- Saw the saw and attach it securely to the cutting foot of the shaft (i.e. trunk side) or has a separate chord from the tool
- Pull the saw of the cluster while the branch is lifted, if necessary,
- If necessary, use a hand saw or a second chainsaw to release the chain saw.

4. Cutting work

The tool should only be used to cut trees. Do not use it for other applications.

Do not attempt to remove the chainsaw when it is stuck during operation. Stop the machine and remove the wedge blade with a wedge.

Stick your feet well, keep a good balance and do not climb on the tree trunk.

Try not to work on a slope. However, if you have to work on a slope, always stand higher than the tree trunk.

Before bending a branch or trunk in bending, observe the direction of bending and finish the cut opposite the bending side to prevent the chain guide from getting stuck in the cut.

a. Felling of trees

Examine the work area and estimate where the tree will fall. Start the machine as described above. Start by making a notch in the direction of fall chosen.

When the tree falls, shout or make a beep to alert people in the vicinity. When the shaft falls, move away from the cutting area.

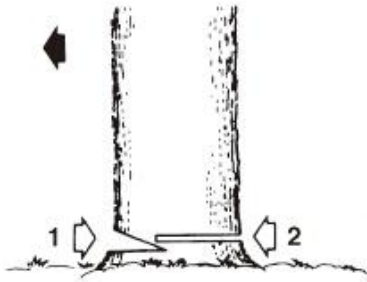

b. Trunk on the ground

Cut half of the trunk, turn it over and finish the cut on the other side.

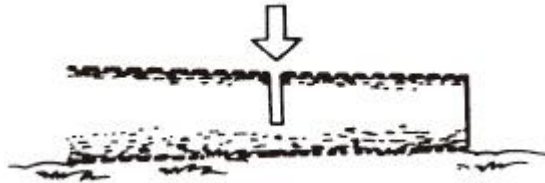

c. Trunk in elevation

Begin by cutting a first part from below and then from above. Then, on the second part, repeat this operation.

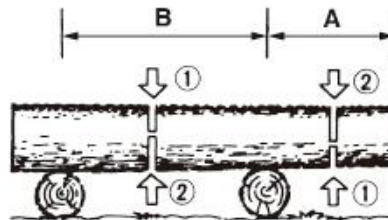

5. Pruning of a felled tree

Observe first the direction of flexion of the branch. Make a first notch on the side in flexion and finish the cut on the opposite side.

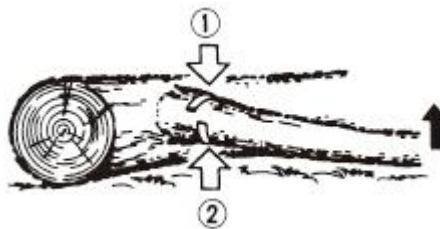

6. Pruning a tree

Begin pruning by nicking the tree from below and then finish at the top.

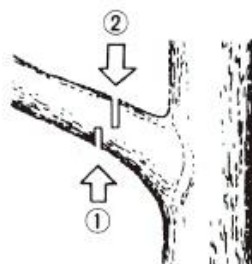

5. MAINTENANCE AND STORAGE

1. Maintenance

Before any maintenance work, the machine must be switched off and completely cooled. Perform the maintenance work according to the instructions below and perform them regularly. A clean, well-maintained machine increases its standard of living and efficiency. On the contrary, a machine maintained can cause damage, accidents and render the tool inoperable in the short term. Any other maintenance, modification or repair work must be carried out by a qualified professional. Do not immerse the tool in water or any other liquid.

a. After each use

Keep saw body clean, use a soft cloth dampened with a mild soap and water mixture, wipe saw body to clean.

b. Guide bar

Cleaning: Remove bar guide to remove dirt from grooves and oil inlet. Regularly grease the pinion.

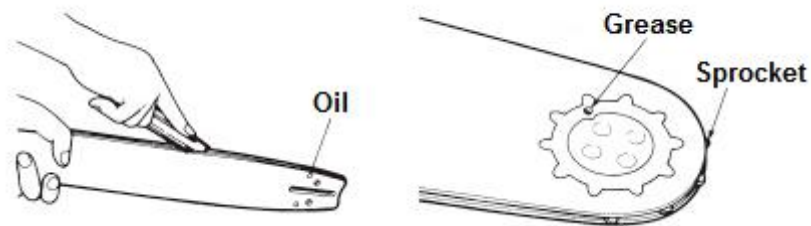

Check: Reverse the bar from time to time to avoid the effects of wear. The bar rail should always be in place. Use a ruler to observe it. If a gap is observed between them, then the rail is normal. Otherwise, the rail is worn out. A bar must be corrected or replaced.

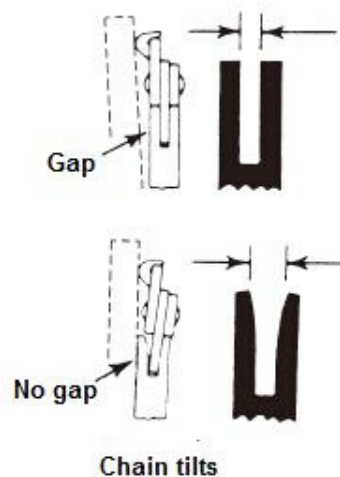

c. Sprocket

Check the sprocket on signs of wear. If wearing is important, replace it with a new one. Do not install a chain on a worn or damaged sprocket. Do not install a worn chain on a pinion.



d. chain saw

Check each time the cutter and cutting angles are as shown below.

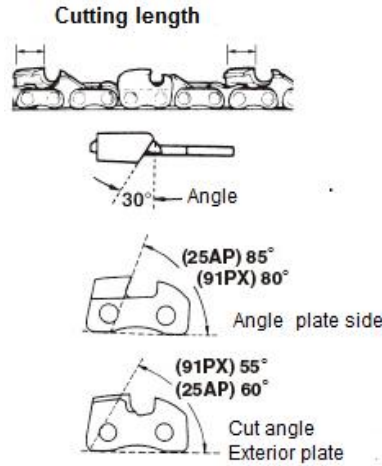

e. Sharpening of the chain

For best performance, we strongly recommend that you periodically sharpen the chain. The chain can either be sharpened by a professional or by yourself by providing you with a sharpening guide (make sure you know how to use it).

The chain must be sharpened when:

- Wood chips have become powder
- To perform a normal cut, force on the tool#
- The cut is not straight
- Vibration increase
- Fuel consumption has increased
- Sharpening method:

The chain saw must be switched off and locked before sharpening. Use a round file or sharpening device (see in store).

Place the file on the tooth and push straight. Shift with the same movement.

After sharpening all teeth, check if the teeth are sharp.

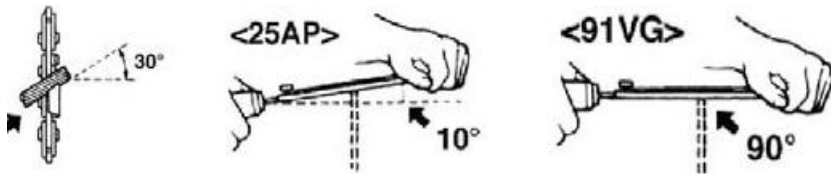

2. STORAGE

When storing, the tool must be turned off, cooled, emptied of fuel and thoroughly cleaned. Store the tool in a dry, clean place, preferably in its packaging, and out of the reach of children. Store all accessories and other items with the tool

6. DISPOSAL



Electrical products should not be discarded with household products. According to the European Directive 2012/19/EU on waste electrical and electronic equipment and its implementation into national law, electrical products used must be collected separately and disposed of at collection points provided for this purpose. Talk with your local authorities or dealer for advice on recycling.

7. DECLARATION OF CONFORMITY



BUILDER SAS
ZI, 32 rue Aristide Bergès – 31270 Cugnaux - France

Declares that the machinery designated below:

Chainsaw

RAC2040ECS-A
Serial number: **20190515737-20190516536**

**Complies with the provisions of the Directive "machinery" 2006/42/EC and regulations
National transposing it;**

Also complies with the following European directives:

EMC Directive 2014/30/EU
RoHS Directive 2011/65/EU
Noise emission Directive 2000/14/EC Annex V and Directive 2005/88/EC
Guarantee sound power level: 107 dB(A)
Measured sound power level: 104.2dB (A) $K_{WA}=3dB(A)$

Also complies with European standards, national standards and provisions following techniques:

EN 60745-1:2009+A11:2010
EN 60745-2-13:2009+A1:2010
EN55014-2:2017
EN55014-2:2015
EN61000-3-2:2014
EN61000-3-3:2013

Notified body: SGS Fimko Ltd Sarkiniementie 3 P.O. Box FI-00211 Helsinki Finland Code: 0598

Responsible of the Technical file: Mr Patriarca

Cugnaux, 25/03/2019

Philippe MARIE / PDG

